

Article number: 20288B50B45T2SW

Description: E+G Swivel clamp - GN 288-B50-B45-T-2-SW

Measures

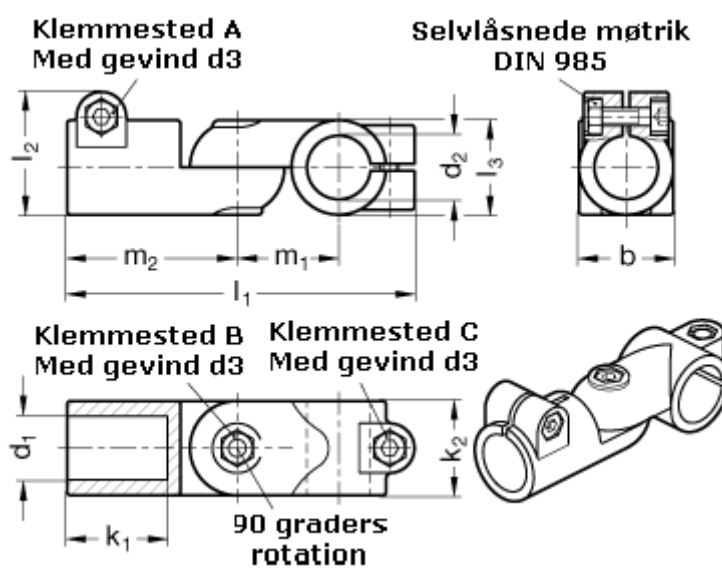

$b = 65$	$m_1 = 70$
$d_1 = B50$	$m_2 = 115$
$d_2 = B45$	
$d_3 = M10$	
$k_1 = 74.0$	
$k_2 = 65$	
$l_1 = 230$	
$l_2 = 77.5$	